

Quick Installation Guide

205TX 5-Port 100M Unmanaged Ethernet Switch

www.avcomm.cn

• Overview

205TX is a 5-port 10/100Base-TX unmanaged Ethernet switch with reverse polarity protection of DC input. It has ingenious appearance design and supports DIN Rail-mounted to facilitate in various industrial network applications.

• Package Checklist

- 1 x Product Unit
- 1 x Quick Installation Guide

• Installation

DIN Rail-mounted

To mount the switch on the DIN Rail track, insert the upper end of the DIN- Rail clip into the back of the DIN- Rail track from its upper side and lightly push the bottom of the DIN- Rail clip into the track. The DIN Rail should comply with DIN EN50022 standard. Using wrong DIN rail may cause unsafe installation.



Power Connection Diagram

AC/DC input cable connection diagram for 3 or 5 Ports Model

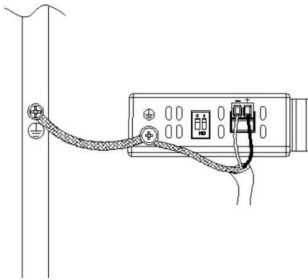

[NOTE]: Before connecting the device to the AC/DC power inputs, make sure the AC/DC power source voltage is stable. L/+ end is connected to the positive AC/DC wire. N/- end is connected to the

• Dimension

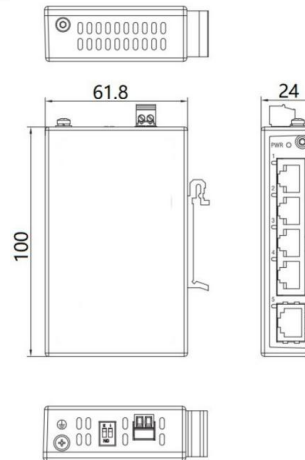

• Indicator

LED	State		Description
Power(PWR)	Green	On	Power is being supplied to power input.
		Off	Power is not being supplied to power input.
Ports (Full 1000M)	Green	On	When the port is active and links on 1000 Mbps.
		Blinking	When the port's data is being transmitted at 1000 Mbps.
		Off	When the port is inactive or link down.
	Amber	On	When the port is active and links on 100 Mbps.
		Blinking	When the port's data is being transmitted at 100 Mbps.
		Off	When the port is inactive or link down.
Ports (Full 100M)	Green	On	When the port is active and links on 100 Mbps.
		Blinking	When the port's data is being transmitted at 100 Mbps.
		Off	When the port is inactive or link down.

• Safety Precautions

- Keep DC power off before connecting to the terminal block connectors and ensure all connections are secure established.
- Do make sure that models connect to the corresponding supply voltage. The device is to be supplied by Limited Power Supply. The relay contact supports 0.5 A current, DC 24V
- **Do not touch the surface of the switch while it is in operation!**

• Support

At AVCOMM, you can use the online service forms to **request the support**. The submitted forms are stored in server for AVCOMM team member to assign tasks and monitor the status of your service. Please feel free to write to www.avcomm.cn if you encounter any problems.

• Warranty

5-year Global warranty are available for AVCOMM products assuring our customers that the products shall remain free from defects in workmanship or materials and conform in all material respects to AVCOMM specifications, or purchasers supplied and accepted specifications. The warranty is limited to the repair and/or replacement, at AVCOMM sole discretion, of the defective product during its warranty period. The customer must obtain a Return Merchandise Authorization (RMA) approval code prior to returning the defective Product to AVCOMM for service. The customer agrees to prepay shipping charges, to use the original shipping package or equivalent, and to ensure the product or assume the risk of loss or damage in transit. repaired or replaced products are warranted for ninety (90) days from the date of repair or replacement, or for the remainder of the original product's warranty period, whichever is longer.

• Disclaimer

AVCOMM reserves the right to make changes to this QIG or to the product hardware at any time without notice. It is the user's responsibility to determine whether there have been any such updates or amendments herein.

Defects, malfunctions, or failures of the warranted Product(s) caused by damage resulting from unforeseeable incidents (such as lightings, floods, fire, etc.), environmental and atmospheric disturbances, other external forces such as power line disturbances and surge, host computer malfunction and virus, incorrect power input, or incorrect cabling, incorrect grounding and damages caused by misuse, abuse and unauthorized alteration or repair are not warranted.