



Quick Installation Guide

6006GX2-POE Industrial 4G + 2GF L2+/L3 PoE Cyber Security Switch

www.avcomm.cn

Overview

The new 6006GX2-POE is full Gigabit Managed Switch with Layer 2 functions. Both switches provide more flexibility in planning a large-scale IP network. 6006GX2-POE is equipped with 4-port 10/100/1000Base-T RJ-45 and 2-port 100/1000 Base-X SFP connectivity, where 6006GX2-POE supported 8 x100M 802.3at PoE ports. These switches provide reliable network with high performance. It supports critical cyber security features that meet IEC62443-4-2 criteria. Advanced management and redundancy features guarantee the fastest network recovery, zero packet loss data transmission, and high level of network protection against the hackers' attacks. Besides, for 6006GX2-POE, it has a rugged design with EN 61850-3/IEEE 1613/EN 50121-4 standard which is the best choice for substation and railway wayside applications.

	6006GX2-POE
10/100Base-T	4
100/1000Base SFP	2
PoE Mode	IEEE 802.3af/at
Power input	46~57VDC (50~57VDC for 802.3at)

Package Checklist

- 1 x Product Unit (Without SFP transceiver)
 - 1 x 8-pin Removable Terminal Connector
 - 1 x Din Clip
 - 1 x Quick Installation Guide
- Optional Accessory (for detailed information please refer to the Datasheet):*
- 10Gbps SFP+ Transceiver
 - 1000Mbps SFP Transceiver
 - RS232 Console Cable
 - Wall-mounting kit with 2 plates and 8 screws

Installation

DIN Rail mount

To mount the switch on the DIN Rail track, insert the upper end of the DIN-Rail clip into the back of the DIN-Rail track from its upper side and lightly push the bottom of the DIN-Rail clip into the track. The DIN Rail should comply with DIN EN50022 standard. Using wrong DIN rail may cause unsafe installation.

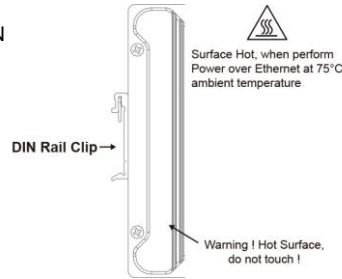

Grounding Screw

For avoiding system damage by noise or electric shock, establish a direct connection between the ground screw and the grounding surface prior to connecting devices.

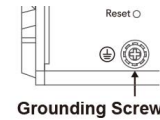

Wiring the Relay Output

The relay output of the 2-pin terminal block connector are used to detect user-configured events. The two wires attached to the fault contacts form a close circuit when a user-configured event is triggered. If a user-configured event does not occur, the fault circuit remains opened.

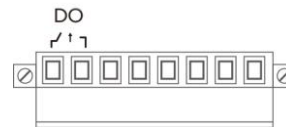

Wiring the Power Input

- 1) Insert the positive and negative wires into the V+ and V- contact on the terminal block connector.
- 2) Tighten screws when the wire is connected.
- 3) Connect the power wires to suitable DC Switching type power supply.



Wiring the Digital Input

To wire the DI on the Terminal block, loosen screws by screw driver on the terminal block connector, insert the positive and negative wires into the V+ and V- contact and then tighten screws after the DI wire is connected.

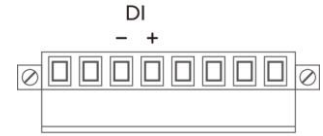

USB Port

Use the USB port in order to save or restore the configuration and upload the firmware upgrade file. For further configurations, please refer to User Manual.

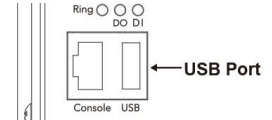

Appearance

6006GX2-POE

System LED

- 2 x Power
- 1 x System Status
- 1 x DO
- 2 x Fiber Port
- 1 x Ring
- 4 x PoE

Gigabit Ethernet

- 4 x 100/1000M RJ45
- IEEE 802.3af/at

Fiber Ethernet

- 2 x 100M/1000M SFP

Easy System Management

- USB for Configuration/ Firmware update

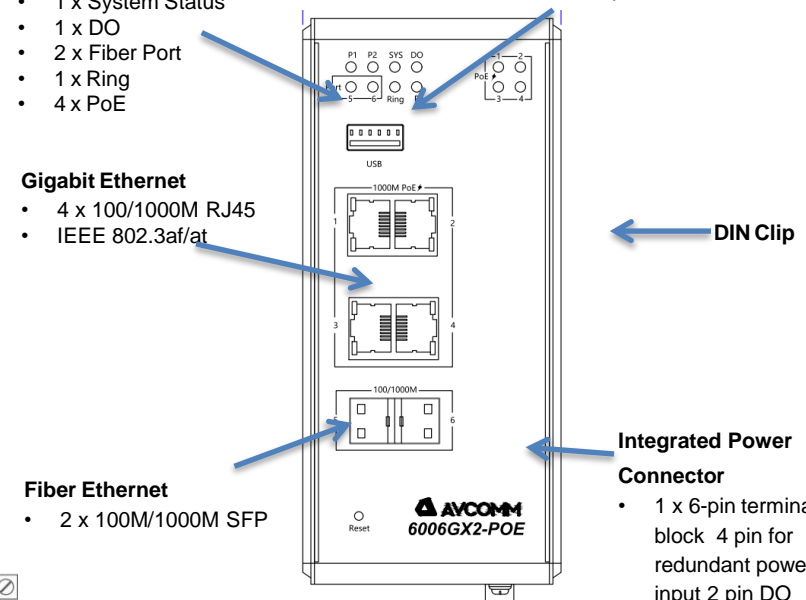

• LED Indication

6006GX2-POE

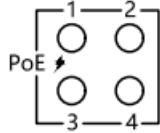
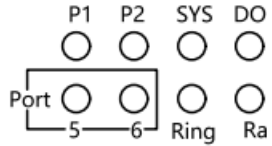

LED	Status	Description
PWR (P1/P2)	Green On	DC-IN Power is On
	Off	No Power in DC-IN
System LED	Green On	Ready
	Green Blinking	Firmware Updating
	Off	Not Ready
Ring LED	Green On	Not Owner/Normal
	Green Blinking	Owner/Normal
	Amber On	Abnormal
	Amber Blinking	Ring Port Fail
	Off	Ring is disabled
Alarm (DO)	Red On	Any failures in port link, ping, power, DO and DI State by SW control
	Off	No failure occurs
Digital Input (DI)	Green On	Detected Digital Input
	Off	No Digital Input
PoE LED 1~4 (6006GX2-POE)	Amber On	PoE delivering in progress
	Amber Off	PoE is disabled / No Powered Device
1000M Ethernet (Port1-4)	Green On	Links established
	Green Blinking	Packets transmitting/receiving
	Green Off	Link is inactive
	Amber On	Link Speed 1000M
	Amber Off	Link speed 100M

LED	Status	Description
SFP Port (Port5~6)	Green On	Links established
	Green Blinking	Packets transmitting/receiving
	Green Off	Link is inactive
	Amber On	Link Speed 1000M
	Amber Off	Link speed 100M

• Safety Precautions

- Turn off DC power input source before connecting the DC Power supply module to the terminal block connectors. Do not turn-on the source of DC power module and make sure all connections were well established, then power on the DC source to powering the Switch device.
- Do make sure that models connect to the corresponding supply voltage. The device is to be supplied by Limited Power Supply. The relay contact supports 0.5 A current, DC 24V.
- **Do not touch the surface of the switch while it is performing PoE function!**

• Management

This device supports both in-band and out-of-band network management. The user can either configure the device through the user friendly Web/HTTPS management or remotely manage the device through the network by console management or Telnet/SSH.

1. Preparation for **Web management**: First of all, verify that device is properly installed in the network and that every PC of this network can access the switch through the web browser (Google Chrome, Internet Explorer, Mozilla Firefox).
 - Type http://IP_address in your browser (the default IP address is <http://192.168.10.1/>)
 - Key in the user name and password in login screen. The default user name and password is **admin**.
 - After you click OK, the Welcome page of the web-based management interface will appear.
 - On the left side you can see the list of software features, on the right side – available settings.
- ◆ To link with the device, please make sure that the IP Address of the PC is located in the same subnet (**192.168.10.x**).
2. Preparation for **Console management (using RS232 Port)**:
 - Connect console cable between your PC and the device.
 - Start -> Program -> Accessories -> Communication -> Hyper Terminal.
 - Give a name to a new console connection.
 - Choose the COM name and select correct serial settings: Baud Rate: 115200 / Parity: None / Data Bit: 8 / Stop Bit: 1
 - After connected, type the username **admin** and password **admin** to login.
 - Follow the User Manual to configure the software features.

3. Preparation for **Telnet/SSH management**: You can connect to the device by Telnet and the command lines are the same as what you see by console management. Below are the steps to open Telnet connection to the switch.

- Start -> Open Command prompt ->Enter
- Type the Telnet 192.168.10.1 (or the IP address of the switch). And then press Enter.

SSH (Secure Shell)

The device also supports SSH console. You can remotely connect to the switch to access command line interface. The SSH connection can secure all the configuration commands you sent to the switch. SSH is a client/server architecture while the Switch is the SSH server. When you want to make SSH connection with the switch, you should download the SSH client tool first.

SSH Client

There are many free, sharewares, trials or charged SSH clients you can find on the internet.

- ◆ **For further feature configurations, please refer to User Manual.**

• Support

At AVCOMM, you can use the online service forms to **request the support**. The submitted forms are stored in server for AVCOMM team member to assign tasks and monitor the status of your service. Please feel free to write to sales@avcomm.cn if you encounter any problems.

• Warranty

5-year Global warranties are available for AVCOMM products assuring our customers that the products shall remain free from defects in workmanship or materials and conform in all material respects to AVCOMM specifications, or Purchaser's supplied and accepted specifications. The warranty is limited to the repair and/or replacement, at AVCOMM sole discretion, of the defective product during its warranty period. The customer must obtain a **Return Merchandise Authorization (RMA)** approval code prior to returning the defective Product to AVCOMM for service. The customer agrees to prepay shipping charges, to use the original shipping container or equivalent, and to insure the Product or assume the risk of loss or damage in transit. Repaired or replaced products are warranted for ninety (90) days from the date of repair or replacement, or for the remainder of the original product's warranty period, whichever is longer.

• Disclaimer

AVCOMM reserves the right to make changes to this QIG or to the product hardware at any time without notice. It is the user's responsibility to determine whether there have been any such updates or amendments herein.

Defects, malfunctions, or failures of the warranted Product(s) caused by damage resulting from unforeseeable incidents (such as lightings, floods, fire, etc.), environmental and atmospheric disturbances, other external forces such as power line disturbances and surge, host computer malfunction and virus, incorrect power input, or incorrect cabling, incorrect grounding and damages caused by misuse, abuse and unauthorized alteration or repair are not warranted.